

6FHX51

8Ω**Coaxials** - 6.5 Inches

- 300 W continuous program power capacity
- 70° nominal coverage
- 85 - 18000 Hz response
- 93 dB sensitivity
- 20.1 mm (0.79") HF unit exit diameter

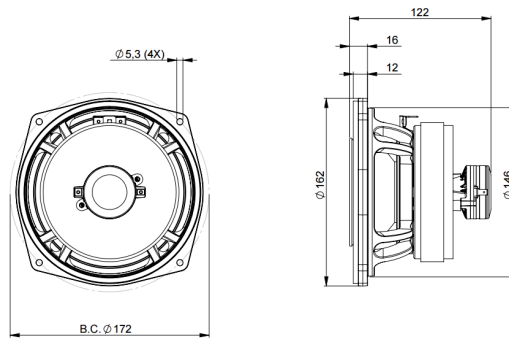

6FHX51

Coaxials- 6.5 Inches

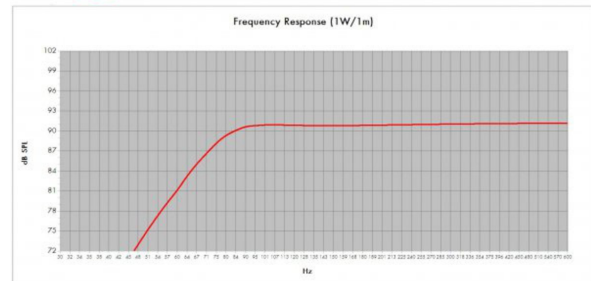
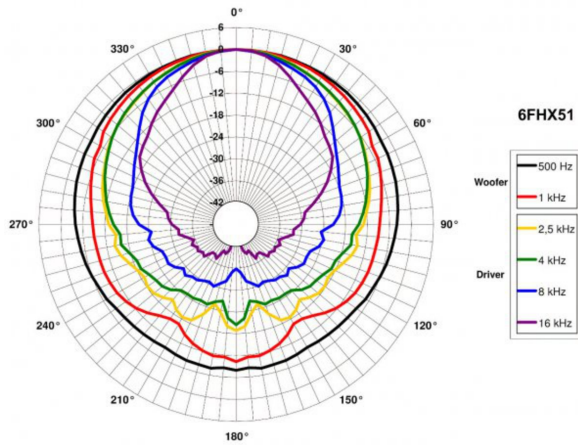
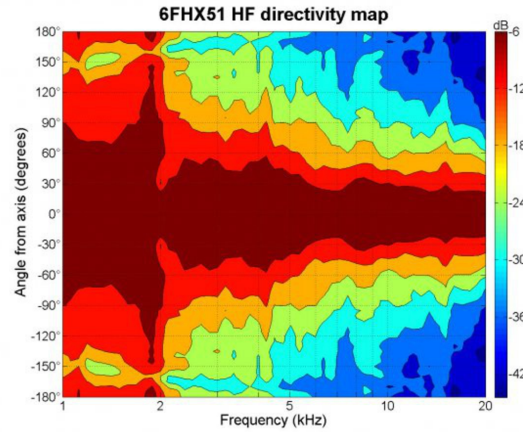
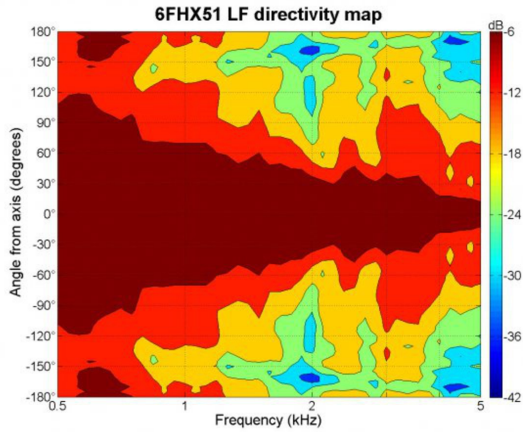
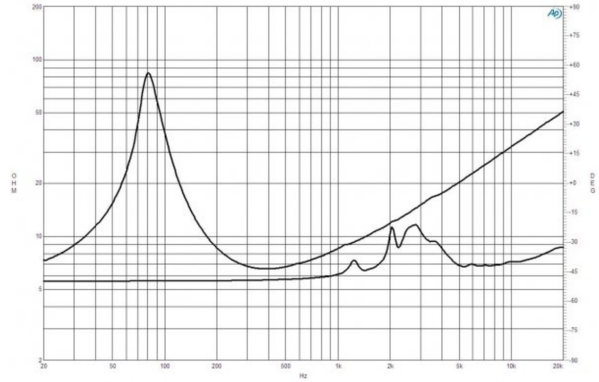
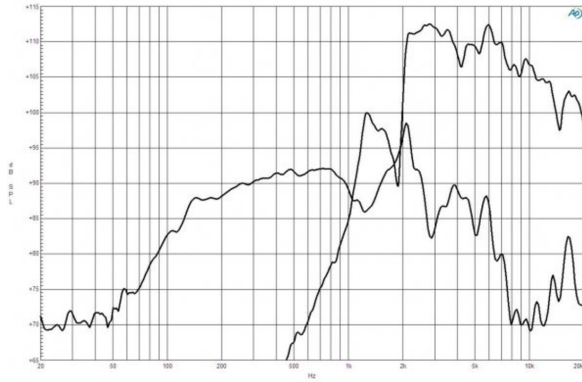

Model:	6FHX51	Configuration:	One Driver
Enclosure Type:	Basin Reflex		
Internal Net Volume (liters):	7	GR: d	
Tuning Frequency (Hz):	80	Port Area (cm²):	30,4
Frequency (-3 dB) (Hz):	73,4	Port Length (cm):	15,0

SPECIFICATIONS

Nominal Diameter	170 mm (6.5 in)
Nominal Impedance	8 Ω
Minimum Impedance LF	6.5 Ω
Minimum Impedance HF	7.0 Ω
Frequency Range	85 - 18000 Hz
Dispersion Angle ¹	70 °
Woofer Cone Treatment	WP Waterproof Front Side
Magnet Material	Ferrite (LF) - Neodym. Ring (HF)

SPECIFICATIONS LF UNIT

LF Sensitivity ²	93.0 dB
LF Nominal Power Handling ³	150 W
LF Continuous Power Handling ⁴	300 W
LF Voice Coil Diameter	51 mm (2.0 in)
LF Winding Material	Copper
LF Flux Density	1.05 T
Former Material	Kapton
Winding Depth	13.0 mm (0.51 in)
Magnetic Gap Depth	6.0 mm (0.24 in)

SPECIFICATIONS HF UNIT

HF Sensitivity ⁵	108.5 dB
HF Nominal Power Handling ⁶	10 W
HF Continuous Power Handling ⁷	20 W
HF Voice Coil Diameter	25 mm (1.0 in)
HF Winding Material	Aluminium
HF Flux Density	1.65 T
Diaphragm Material	Polyester
Recommended Crossover ⁸	2.5 kHz
Inductance	0.1 mH

B&C Speakers s.p.a.

Via Poggiomoro, 1 - Loc. Vallina, 50012 Bagno a Ripoli (FI) - ITALY - Tel. +39 055 65721 - Fax +39 055 6572312 - mail@bcspeakers.com

PARAMETERS

Resonance Frequency	85 Hz
Re	5.5 Ω
Qes	0.4
Qms	7.8
Qts	0.37
Vas	5.0 dm ³ (0.18 ft ³)
Sd	132.0 cm ² (20.5 in ²)
η _e	0.83 %
Xmax	± 5.0 mm
Xvar	± 5.7 mm
Mms	16.0 g
Bl	11.3 Txm
Le	1.0 mH
EBP	212 Hz

MOUNTING AND SHIPPING INFO

Overall Diameter	187 mm (7.4 in)
Bolt Circle Diameter	172 mm (6.7 in)
Baffle Cutout Diameter	146 mm (5.75 in)
Depth	122 mm (4.8 in)
Flange and Gasket Thickness	12 mm (0.47 in)
Net Weight	2.6 kg (5.73 lb)
Shipping Units	1
Shipping Weight	3.05 kg (6.72 lb)
Shipping Box	255x255x150 mm (10.04x10.04x5.91 in)

SERVICE KIT

LF recone kit	RCK06FHX518
MF replacement diaphragm	MMDDE58

1. Included by -6 dB down points.
2. Applied RMS Voltage is set to 2.83V.
3. 2 hours test made with continuous pink noise signal within the range Fs-10Fs. Power calculated on rated minimum impedance. Loudspeaker in free air.
4. Power on Continuous Program is defined as 3 dB greater than the Nominal rating.
5. Applied RMS Voltage is set to 2.83V.
6. 2 hour test made with continuous pink noise signal within the range from the recommended crossover frequency to 20 kHz. Power calculated on rated minimum impedance. Loudspeaker in free air.
7. Power on Continuous Program is defined as 3 dB greater than the Nominal rating.
8. 12 dB/oct. or higher slope high-pass filter.