

15DS115

8Ω

LF Drivers - 15.0 Inches

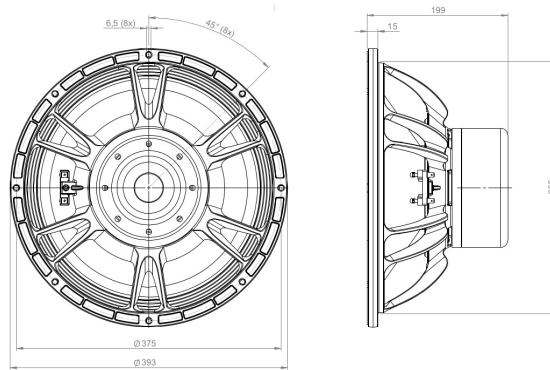

- 3200 W continuous program power capacity
- 116 mm (4.5 in) four layer aluminum voice coil
- 35 - 1000 Hz response
- 97 dB sensitivity
- 60 mm peak-to-peak excursion before damage
- Neodymium magnet allows a very high force factor and linear excursion
- Double silicone spider with optimized compliance
- Ventilated voice coil gap for reduced power compression
- Aluminium demodulating ring for very low distortion



This next evolution subwoofer uses a new, longer, four layer aluminum voice coil. The result is more energy in the gap, less heat, higher sensitivity, higher power handling, lower distortion and better overall performance. The 15DS115 features a 40mm long, 4.5 inch diameter (116mm) Copper Clad Aluminum Wire voice coil. With a 1600watt AES power rating, 97 dB sensitivity, and over 14 mm of Xvar, this high energy subwoofer is a significant step forward from similar models in the B&C range.

15DS115

LF Drivers- 15.0 Inches

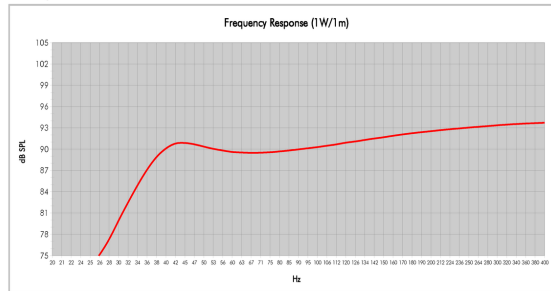
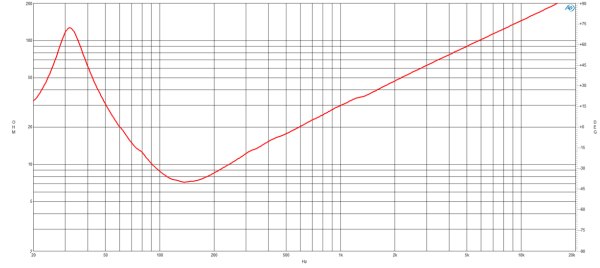
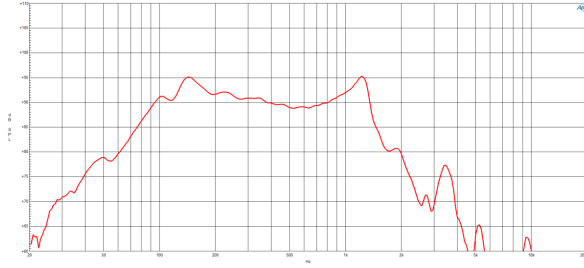

Model: 15DS115
 Enclosure type: Bass Reflex Configuration: One Drive
 Internal Net Volume (litres): 80 QES: 5
 Tuning Frequency (Hz): 40 Port Area (cm²): 200.0
 Frequency (-3 dB) (Hz): -- Port Length (cm): 33.1
 Frequency (-10 dB) (Hz): 33.5

SPECIFICATIONS

Nominal Diameter	380 mm (15.0 in)
Nominal Impedance	8 Ω
Minimum Impedance	7.2 Ω
Nominal Power Handling ¹	1600 W
Continuous power handling ²	3200 W
Sensitivity (1W/1m) ³	97.0 dB
Frequency Range	35 - 1000 Hz
Voice Coil Diameter	116 mm (4.5 in)
Winding Material	Aluminium
Former Material	Glass Fibre
Winding Depth	40.0 mm (1.57 in)
Magnetic Gap Depth	14.0 mm (0.55 in)
Flux Density	0.8 T

DESIGN

Surround Shape	Triple Roll
Cone Shape	Radial
Magnet Material	Neodymium Inside Slug
Spider	Double Silicone
Pole Design	T-Pole
Woofers Cone Treatment	TWP Waterproof Both Sides
Recommended Enclosure	80.0 dm ³ (2.83 ft ³)
Recommended Tuning	40 Hz

PARAMETERS⁴

Resonance Frequency	33 Hz
Re	4.9 Ω
Qes	0.18
Qms	5.2
Qts	0.17
Vas	94.0 dm ³ (3.32 ft ³)
Sd	855.0 cm ² (132.53 in ²)
η _o	1.9 %
X _{max}	± 16.5 mm
X _{var}	± 14.0 mm
M _{ms}	254.0 g
Bl	38.7 Txm
Le	4.5 mH
EBP	183 Hz

MOUNTING AND SHIPPING INFO

Overall Diameter	393 mm (15.47 in)
Bolt Circle Diameter	375 mm (14.76 in)
Baffle Cutout Diameter	354.0 mm (13.94 in)
Depth	199 mm (7.83 in)
Flange and Gasket Thickness	15 mm (0.59 in)
Air Volume Occupied by Driver	7.0 dm ³ (0.25 ft ³)
Net Weight	11.7 kg (25.79 lb)
Shipping Units	1
Shipping Weight	13.0 kg (28.66 lb)
Shipping Box	425x425x224 mm (16.73x16.73x8.82 in)

SERVICE KIT

Recone kit	RCK15DS1158
------------	-------------

1. 2 hours test made with continuous pink noise signal within the range Fs-10Fs. Power calculated on rated minimum impedance. Loudspeaker in free air.
2. Power on Continuous Program is defined as 3 dB greater than the Nominal rating.
3. Applied RMS Voltage is set to 2.83 V for 8 ohms Nominal Impedance.
4. Thiele-Small parameters are measured after a high level 20 Hz sine wave preconditioning test.