

6PEV13

8Ω**LF Drivers** - 6.5 Inches

- 240 W continuous program power capacity
- 38 mm (1.5 in) aluminium voice coil
- 150 - 8000 Hz response
- 99 dB sensitivity

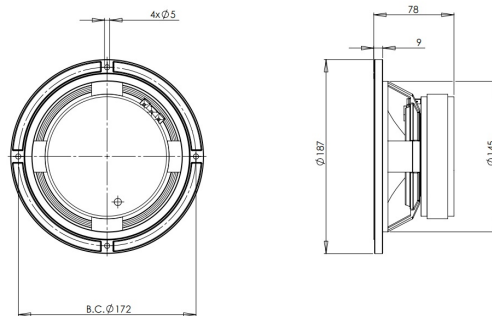

6PEV13

LF Drivers- 6.5 Inches

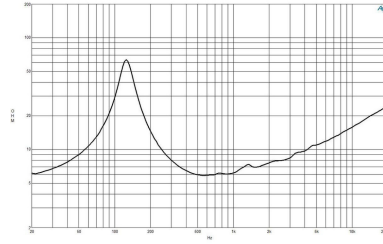
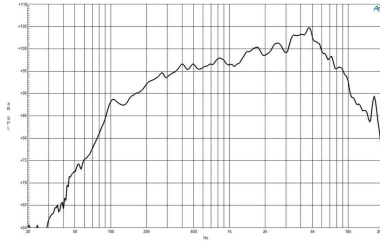

SPECIFICATIONS

Nominal Diameter	170 mm (6.5 in)
Nominal Impedance	8 Ω
Minimum Impedance	6.0 Ω
Nominal Power Handling ¹	120 W
Continuous power handling ²	240 W
Sensitivity (1W/1m) ³	99.0 dB
Frequency Range	150 - 8000 Hz
Voice Coil Diameter	38 mm (1.5 in)
Winding Material	Aluminium
Former Material	Glass Fibre
Winding Depth	7.0 mm (0.28 in)
Magnetic Gap Depth	6.0 mm (0.24 in)
Flux Density	1.4 T

DESIGN

Surround Shape	Flat
Cone Shape	Exponential
Magnet Material	Ferrite
Spider	Single
Pole Design	Straight Pole
Woofer Cone Treatment	None

PARAMETERS⁴

Resonance Frequency	126 Hz
Re	5.2 Ω
Qes	0.39
Qms	4.6
Qts	0.36
Vas	6.0 dm ³ (0.21 ft ³)
Sd	132.0 cm ² (20.46 in ²)
η_0	3.0 %
Xmax	\pm 2.5 mm
Xvar	\pm 1.5 mm
Mms	6.0 g
Bl	8.2 Txm
Le	0.6 mH
EBP	323 Hz

MOUNTING AND SHIPPING INFO

Overall Diameter	187 mm (7.36 in)
Bolt Circle Diameter	172 mm (6.77 in)
Baffle Cutout Diameter	145.0 mm (5.71 in)
Depth	78 mm (3.07 in)
Flange and Gasket Thickness	11 mm (0.43 in)
Air Volume Occupied by Driver	0.8 dm ³ (0.03 ft ³)
Net Weight	2.4 kg (5.29 lb)
Shipping Units	1
Shipping Weight	2.6 kg (5.73 lb)
Shipping Box	210x210x125 mm (8.27x8.27x4.92 in)

SERVICE KIT

Recone kit	RCK06PEV138
------------	-------------

1. 2 hours test made with continuous pink noise signal within the range Fs-10Fs. Power calculated on rated minimum impedance. Loudspeaker in free air.
2. Power on Continuous Program is defined as 3 dB greater than the Nominal rating.
3. Applied RMS Voltage is set to 2.83 V for 8 ohms Nominal Impedance.
4. Thiele-Small parameters are measured after a high level 20 Hz sine wave preconditioning test.